

RCR17

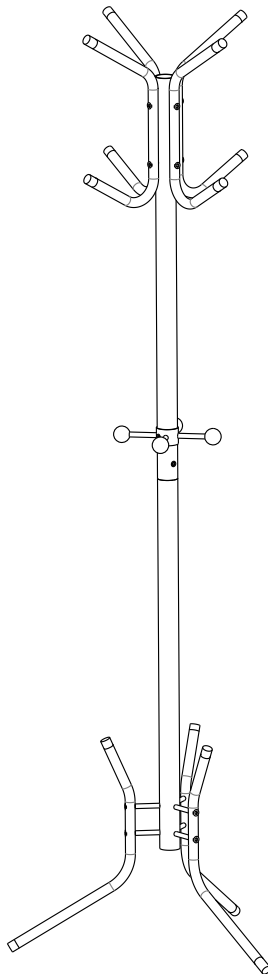

EN

Notes

- Thanks for choosing our product. Please carefully read the manual before the assembly and the use. If the product is transferred to a third person, the manual should be handed over together.
- Please place the coat stand on the flat surface to keep balance.
- Make sure that all accessories are tightened firmly before the use.
- Not be allowed to next to high temperature or children for the safety.
- Hook the clothes evenly to prevent the stand toppling over.

DE

Hinweise

- Danke, dass Sie sich für unser Produkt entschieden haben. Bitte lesen Sie die Bedienungsanleitung aufmerksam durch, bevor Sie das Produkt montieren oder benutzen, um Schäden durch nicht sachgemäßen Gebrauch zu vermeiden. Sollten Sie dieses Produkt an Dritte weitergeben, muss diese Bedienungsanleitung mit ausgehändigt werden.
- Bitte stellen Sie den Kleiderständer auf eine horizontale Ebene, um das Fallen zu vermeiden.
- Benutzen Sie den Kleiderständer, erst nachdem alle Schrauben festgezogen sind.
- Bitte halten Sie den Ständer von Wärmequellen und Feuer fern.
- Hängen Sie die Kleidung gleichmäßig an den Haken, damit der Kleiderständer sich im Gleichgewicht hält.

FR

Notes

- Merci pour choisir le produit de Songmics. Nous vous prions de bien vouloir lire attentivement le mode d'emploi avant de monter ou d'utiliser le produit afin d'éviter des dommages causés par une utilisation non conforme. Si vous souhaitez donner ce produit aux autres, veuillez y joindre cette mode d'emploi.
- Il faudrait mettre le produit sur le sol plat.
- Veuillez serrer toutes les vis avant l'utilisation.
- Gardez l'article loin de la chaleur.
- Pour éviter la chute, merci de ne pas mettre tous vêtements d'un seul côté. Gardez les enfants loin de l'article.

IT









Note

- Si prega di leggere le istruzioni prima di montare o usare questo prodotto per evitare i danni a causa di uso improprio. Se questo prodotto viene trasferito ad una terza persona, questo manuale deve essere trasmesso insieme.
- Il prodotto dovrebbe essere posto su una superficie piana per evitare il ribaltamento del prodotto.
- Assicurare se tutti i viti sono fissati prima dell'uso.
- Il prodotto lontano da fonti di calore.
- Evitare di appendere i vestiti su un lato. Vietare i bambini di giocare con questo prodotto, al fine di evitare di spingerlo e feriscono i bambini.

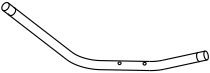
ES

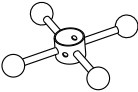
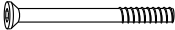
Notas

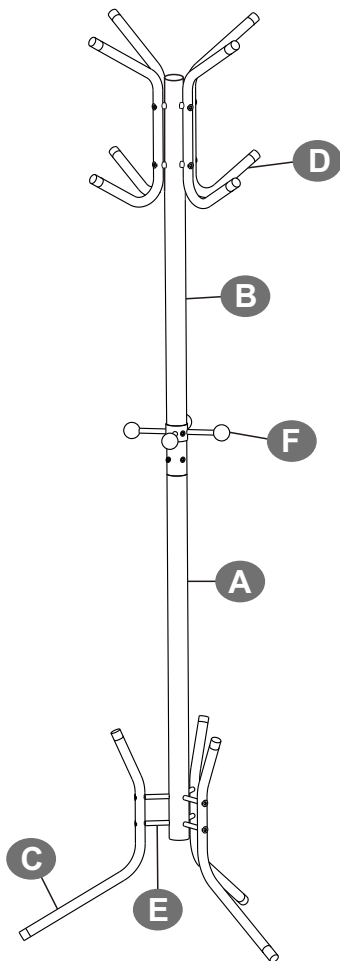

- Gracias por comprar nuestro producto. Por favor, lea detenidamente las instrucciones antes del montaje y el uso, a fin de evitar los daños causados por el uso inadecuado. Si se regala a otra persona, asegúrese de que se incluye este manual también.
- Ha de colocar el perchero en un suelo plano y evitar la inclinación o la caída.
- Antes del uso, asegúrese de que todas las piezas, como los tornillos y tuerca, estén fijadas firmemente.
- No se deje el perchero al lado de la chimenea para evitar el calor.
- No se cuelgue la ropa a un solo lado del perchero, de lo contrario, causará una inclinación. No permite que los niños jueguen alrededor para evitar la caída encima.

<p>A × 1</p>  <p>745mm</p>	<p>B × 1</p>  <p>745mm</p>	<p>C × 3</p> 
<p>D × 4</p> 	<p>E × 6</p>  <p>45mm</p>	<p>F × 1</p> 
<p>G × 6</p> 	<p>H × 8</p> 	<p>I × 4</p> 
<p>J × 8</p> 	<p>K × 1</p> 	



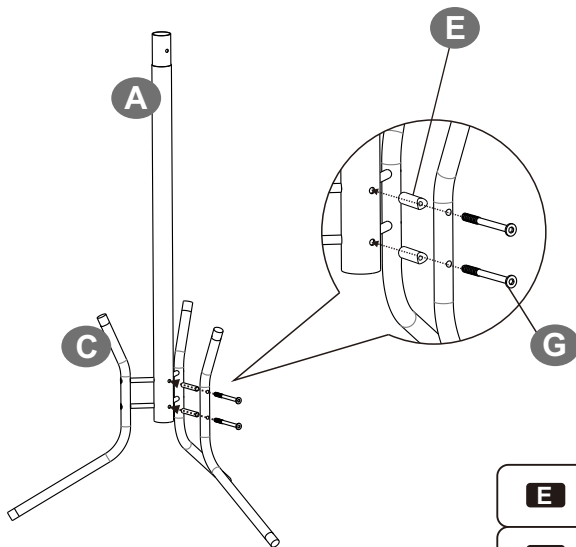

1



E		6PCS
G		6PCS

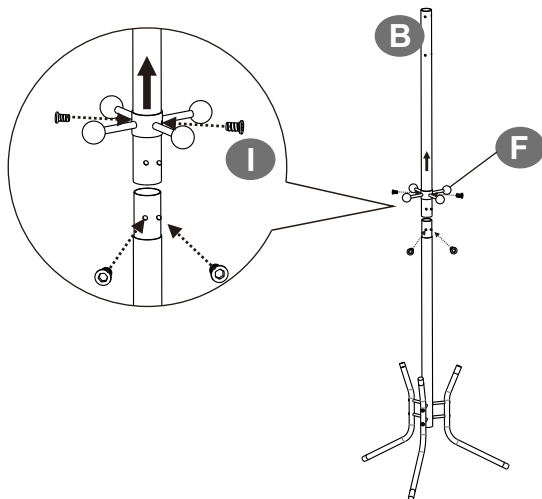

2

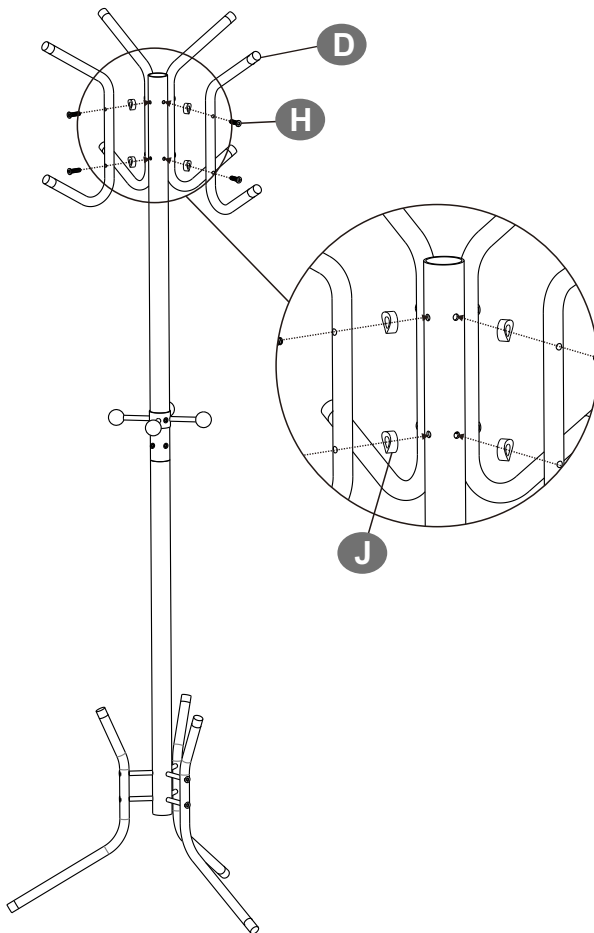

I		4PCS
----------	---	------

3



H		8PCS
J		8PCS

4

